



HD-QCH Quick Cleaner Head
Model: HD-QCH-500



CONTENTS

SAFETY:	3-7
Safety Precautions	3
Hazards / Safeguards	4
INTRODUCTION:	8
Clean Equipment Extremely Efficiently With Less Solvent	8
Specifications	8
INSTALLATION:	9-11
Grounding and Mounting.....	9
OPERATION:	12-13
How To Use	12
MAINTENANCE:	13
Cleaning	13
PARTS IDENTIFICATION:	14-15
HD-QCH-500 - Parts List	14

SAFETY

SAFETY PRECAUTIONS

Before operating, maintaining or servicing any electrostatic coating system, read and understand all of the technical and safety literature for your products. This manual contains information that is important for you to know and understand. This information relates to **USER SAFETY** and **PREVENTING EQUIPMENT PROBLEMS**. To help you recognize this information, we use the following symbols. Please pay particular attention to these sections.

WARNING

A WARNING! states information to alert you to a situation that might cause serious injury if instructions are not followed.

CAUTION

A CAUTION! states information that tells how to prevent damage to equipment or how to avoid a situation that might cause minor injury.

NOTE

A NOTE is information relevant to the procedure in progress.

While this manual lists standard specifications and service procedures, some minor deviations may be found between this literature and your equipment. Differences in local codes and plant requirements, material delivery requirements, etc., make such variations inevitable. Compare this manual with your system installation drawings and associated equipment manuals to reconcile such differences.

Careful study and continued use of this manual will provide a better understanding of the equipment and process, resulting in more efficient operation, longer trouble-free service and faster, easier troubleshooting. If you do not have the manuals and safety literature for your equipment, contact your local Carlisle Fluid Technologies representative or Carlisle Fluid Technologies technical support.

WARNING



- The user **MUST** read and be familiar with the Safety Section in this manual and the safety literature therein identified.
- This equipment is intended to be used by trained personnel **ONLY**.
- This manual **MUST** be read and thoroughly understood by **ALL** personnel who operate, clean or maintain this equipment! Special care should be taken to ensure that the **WARNINGS** and safety requirements for operating and servicing the equipment are followed. The user should be aware of and adhere to **ALL** local building and fire codes and ordinances as well as **NFPA 33 AND EN 16985 SAFETY STANDARDS, LATEST EDITION**, or applicable country safety standards, prior to installing, operating, and/or servicing this equipment.

WARNING



- The hazards shown on the following pages may occur during the normal use of this equipment.

Repairs may only be performed by personnel authorized by Carlisle Fluid Technologies.

AREA Tells where hazards may occur.	HAZARD Tells what the hazard is.	SAFEGUARDS Tells how to avoid the hazard.
<p>Spray Area</p> 	<p>Fire Hazard</p> <p>Improper or inadequate operation and maintenance procedures will cause a fire hazard.</p> <p>Protection against inadvertent arcing that is capable of causing fire or explosion is lost if any safety interlocks are disabled during operation. Frequent Power Supply or Controller shutdown indicates a problem in the system requiring correction.</p>	<p>Fire extinguishing equipment must be present in the spray area and tested periodically.</p> <p>Spray areas must be kept clean to prevent the accumulation of combustible residues.</p> <p>Smoking must never be allowed in the spray area.</p> <p>The high voltage supplied to the atomizer must be turned off prior to cleaning, flushing, or maintenance.</p> <p>Spray booth ventilation must be kept at the rates required by NFPA 33, EN 16985, country, and local codes. In addition, ventilation must be maintained during cleaning operations using flammable or combustible solvents.</p> <p>Electrostatic arcing must be prevented. Safe sparking distance must be maintained between the parts being coated and the applicator. A distance of 1 inch (25mm) for every 10KV of output voltage is required at all times.</p> <p>Test only in areas free of combustible material. Testing may require high voltage to be on, but only as instructed.</p> <p>Non-factory replacement parts or unauthorized equipment modifications may cause fire or injury. If used, the key switch bypass is intended for use only during setup operations. Production should never be done with safety interlocks disabled.</p> <p>The paint process and equipment should be set up and operated in accordance with NFPA 33, NEC, OSHA, local, country, and European Health and Safety Norms.</p>

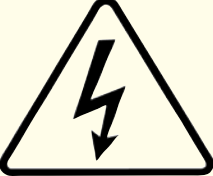
<p>AREA Tells where hazards may occur.</p>	<p>HAZARD Tells what the hazard is.</p>	<p>SAFEGUARDS Tells how to avoid the hazard.</p>
<p>Spray Area</p> 	<p>Explosion Hazard</p> <p>Improper or inadequate operation and maintenance procedures will cause a fire hazard.</p> <p>Protection against inadvertent arcing that is capable of causing fire or explosion is lost if any safety interlocks are disabled during operation.</p> <p>Frequent Power Supply or Controller shutdown indicates a problem in the system requiring correction.</p>	<p>Electrostatic arcing must be prevented. Safe sparking distance must be maintained between the parts being coated and the applicator. A distance of 1 inch (25mm) for every 10KV of output voltage is required at all times.</p> <p>Unless specifically approved for use in hazardous locations, all electrical equipment must be located outside or applicable county code hazardous areas, in accordance with NFPA 33.</p> <p>Test only in areas free of flammable or combustible materials.</p> <p>The current overload sensitivity (if equipped) MUST be set as described in the corresponding section of the equipment manual. Protection against inadvertent arcing that is capable of causing fire or explosion is lost if the current overload sensitivity is not properly set. Frequent power supply shutdown indicates a problem in the system which requires correction.</p> <p>Always turn the control panel power off prior to flushing, cleaning, or working on spray system equipment.</p> <p>Before turning high voltage on, make sure no objects are within the safe sparking distance.</p> <p>Ensure that the control panel is interlocked with the ventilation system and conveyor in accordance with NFPA-33, EN 16985.</p> <p>Have fire extinguishing equipment readily available and tested periodically.</p>
<p>General Use and Maintenance</p> 	<p>Improper operation or maintenance may create a hazard.</p> <p>Personnel must be properly trained in the use of this equipment.</p>	<p>Personnel must be given training in accordance with the requirements of NFPA 33.</p> <p>Instructions and safety precautions must be read and understood prior to using this equipment.</p> <p>Comply with appropriate local, state, and national codes governing ventilation, fire protection, operation maintenance, and housekeeping. Reference OSHA, NFPA 33, EN Norms and your insurance company requirements.</p>

AREA Tells where hazards may occur.	HAZARD Tells what the hazard is.	SAFEGUARDS Tells how to avoid the hazard.
<p>Spray Area / High Voltage Equipment</p> 	<p>Electrical Discharge</p> <p>There is a high voltage device that can induce an electrical charge on ungrounded objects which is capable of igniting coating materials.</p> <p>Inadequate grounding will cause a spark hazard. A spark can ignite many coating materials and cause a fire or explosion.</p>	<p>Parts being sprayed and operators in the spray area must be properly grounded.</p> <p>Parts being sprayed must be supported on conveyors or hangers that are properly grounded. The resistance between the part and earth ground must not exceed 1 Meg Ohm. (Refer to NFPA 33, EN 16985.)</p> <p>Operators must be grounded. Grounding straps on wrists or legs may be used to assure adequate ground contact.</p> <p>Footware to be used by operator shall comply with EN ISO 20344, resistance not to exceed 100 Meg Ohm. Protective clothing including gloves should comply with EN 1149-5, resistance not to exceed 100 Meg Ohm.</p> <p>Operators must not be wearing or carrying any ungrounded metal objects.</p> <p>When using an electrostatic handgun, operators must assure contact with the handle of the applicator via conductive gloves or gloves with the palm section cut out.</p> <p>NOTE: REFER TO NFPA 33, EN 16985 OR SPECIFIC COUNTRY SAFETY CODES REGARDING PROPER OPERATOR GROUNDING.</p> <p>All electrically conductive objects in the spray area, with the exception of those objects required by the process to be at high voltage, must be grounded. Grounded conductive flooring must be provided in the spray area.</p> <p>Always turn off the power supply prior to flushing, cleaning, or working on spray system equipment or applicable county code.</p> <p>Unless specifically approved for use in hazardous locations, all electrical equipment must be located outside or applicable country code, hazardous areas, in accordance with NFPA 33.</p> <p>Avoid installing an applicator into a fluid system where the solvent supply is ungrounded.</p> <p>Do not touch the applicator electrode while it is energized.</p>

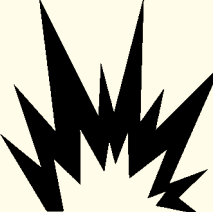
<p>AREA Tells where hazards may occur.</p>	<p>HAZARD Tells what the hazard is.</p>	<p>SAFEGUARDS Tells how to avoid the hazard.</p>
<p>Electrical Equipment</p> 	<p>Electrical Discharge</p> <p>High voltage equipment is utilized in the process. Arcing in the vicinity of flammable or combustible materials may occur. Personnel are exposed to high voltage during operation and maintenance.</p> <p>Protection against inadvertent arcing that may cause a fire or explosion is lost if safety circuits are disabled during operation.</p> <p>Frequent power supply shut-down indicates a problem in the system which requires correction.</p> <p>An electrical arc can ignite coating materials and cause a fire or explosion.</p>	<p>Unless specifically approved for use in hazardous locations, the power supply, control cabinet, and all other electrical equipment must be located outside or applicable country codes, hazardous areas in accordance with NFPA 33 and EN 16985.</p> <p>Turn the power supply OFF before working on the equipment.</p> <p>Test only in areas free of flammable or combustible material.</p> <p>Testing may require high voltage to be on, but only as instructed.</p> <p>Production should never be done with the safety circuits disabled.</p> <p>Before turning the high voltage on, make sure no objects are within the sparking distance.</p>
<p>Toxic Substances</p> 	<p>Chemical Hazard</p> <p>Certain materials may be harmful if inhaled, or if there is contact with the skin.</p>	<p>Follow the requirements of the Safety Data Sheet supplied by coating material manufacturer.</p> <p>Adequate exhaust must be provided to keep the air free of accumulations of toxic materials. Reference EN 12215 or applicable code.</p> <p>Use a mask or respirator whenever there is a chance of inhaling sprayed materials. The mask must be compatible with the material being sprayed and its concentration. Equipment must be as prescribed by an industrial hygienist or safety expert, and be NIOSH approved.</p>
<p>Spray Area</p> 	<p>Explosion Hazard — Incompatible Materials</p> <p>Halogenated hydrocarbon solvents for example: methylene chloride and 1,1,1, - Trichloroethane are not chemically compatible with the aluminum that might be used in many system components. The chemical reaction caused by these solvents reacting with aluminum can become violent and lead to an equipment explosion.</p>	<p>Spray applicators require that aluminum inlet fittings be replaced with stainless steel.</p> <p>Aluminum is widely used in other spray application equipment - such as material pumps, regulators, triggering valves, etc. Halogenated hydrocarbon solvents must never be used with aluminum equipment during spraying, flushing, or cleaning. Read the label or data sheet for the material you intend to spray. If in doubt as to whether or not a coating or cleaning material is compatible, contact your coating supplier. Any other type of solvent may be used with aluminum equipment.</p>

INTRODUCTION



CLEAN EQUIPMENT EXTREMELY EFFICIENTLY WITH LESS SOLVENT

Quick Cleaner Head provides a means of cleaning the inside of material hose, fluid passageways of spray guns, and other paint equipment. It is designed to simultaneously mix solvents and compressed air to pressure flush paint lines and passages quickly and thoroughly, eliminating color contamination and saving time.

The unit is infinitely adjustable allowing for the proper solvent-air ratio to ensure clean fluid passages. Check valves on both air and fluid inlets prevent possible backflow of material into inlets/supply.

Important

1. Read and follow all instructions and SAFETY PRECAUTIONS before using this equipment.
2. Retain for future reference.

Part Number

HD-QCH-500 Quick Cleaner Head

SPECIFICATIONS

Maximum Inlet Working Pressure (Air/Fluid):

6.9 Bar (100psi, 10.69 MPa)

Fluid Passage Materials: Stainless Steel, PTFE, and Nickel Plated Brass

Inlet Threads:

Compatible with 1/4 BSP or 1/4 NPSM Threads

Outlet Threads:

Compatible with 3/8 BSP or 3/8 NPSM Threads



CAUTION

- Insure all inlet feed hoses meet the pressure rating required for the inlet pressure used for air and fluid supply.

INSTALLATION

GROUNDING AND MOUNTING

⚠ WARNING

- This equipment must be fixed to a stable surface at all times during use in order to prevent possible serious injury. (See figures 1, 3 and 4).
- Ensure the unit is at earth ground potential no matter which mounting method is used.

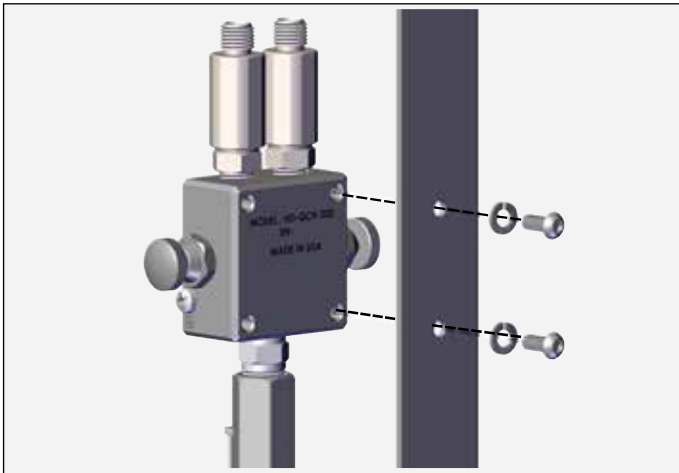

Figure 1: Make two or more holes of between $\varnothing 6.2$ to 6.5 such as in the frame of the mount pad. Attach the device to the mount pad using the included hardware in the mounting kit (HD-QCH-002).

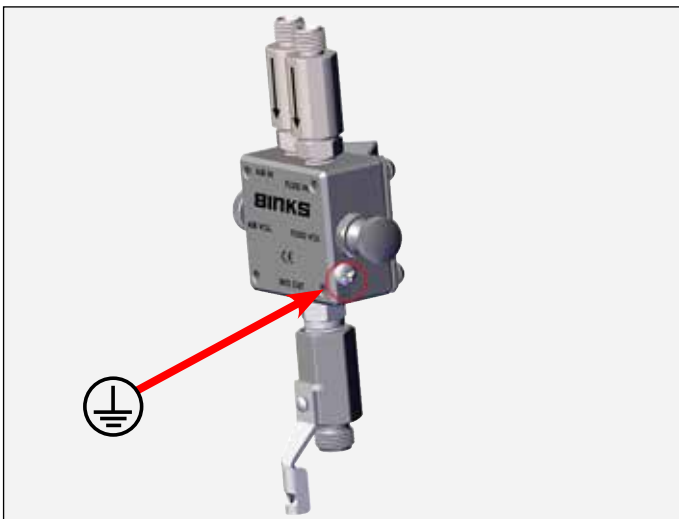

Figure 2: This unit must be connected to true earth ground at all times during use to prevent possible serious injury.

1. Clean, moisture and oil free air supply is necessary. Install mist separator or transformer as close to the unit as possible. Contaminated air may lead to problems with coating or coating equipment including this device.
2. Use clean solvent or water (hereinafter referred to as "cleaning solutions") to be supplied to this device. Running dirty cleaning solutions or paints may cause damage to this device or may result in poor cleaning performance.
3. Connect the cleaning solution hose to the "fluid in" port, air hose to the "air in" port, firmly assuring that both hose connections are tightened adequately. The air connections are compatible with both 1/4 BSPP and 1/4 NPSM threads.
4. An adapter and check valve (SSCV-4-6T, 6T-4T) are attached to the air and fluid inlets on the unit. The check valves are included to prevent the possibility of any cleaning solution back flowing into the air supply/inlet. Do not use the unit without the inclusion of inlet check valves.

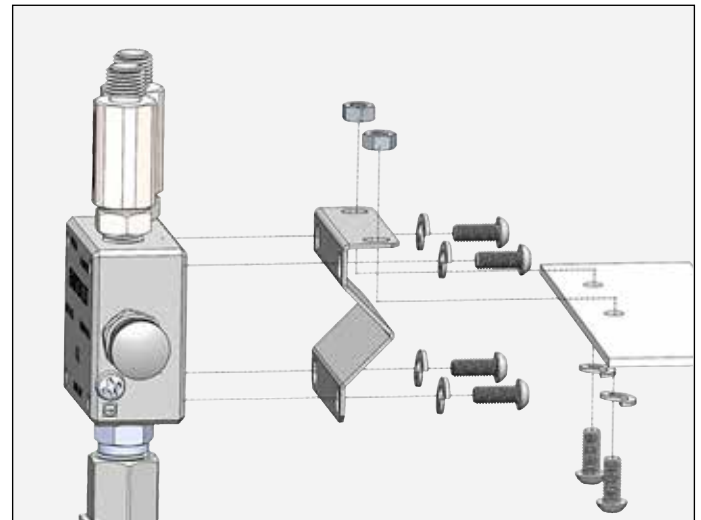

Figure 3: Make two holes of between $\varnothing 6.2$ to 6.5 on the top plate of the mount, attach the multi bracket to the device, and then tighten the top plate and the multi bracket with the included hardware in the bracket kit (HD-QCH-002).

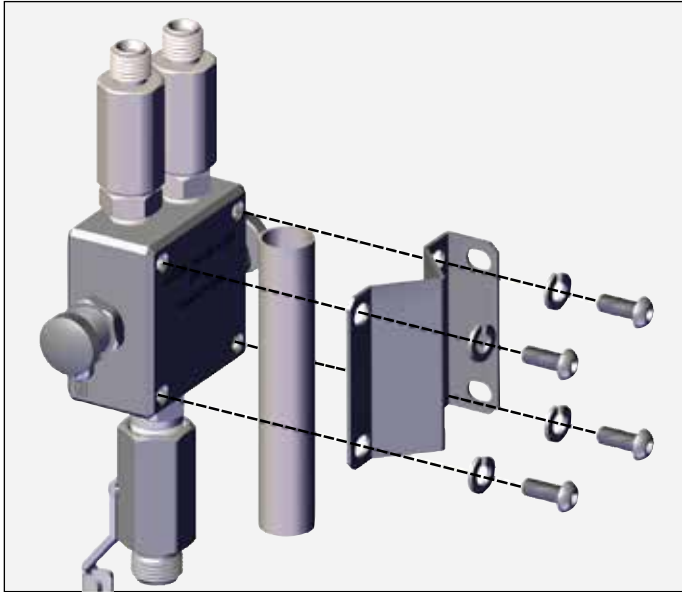
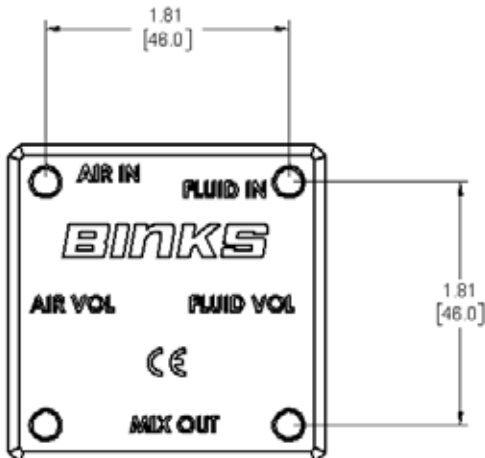

Figure 4: Sandwich the round pipe chosen for mounting between the device and the multi bracket, and tighten them with four bolts included in the mounting kit (HD-QCH-002).

5. Ball valves may be added to the air and/or inlet flow path for more ease of operation and increased safety.

BOLT HOLE MOUNTING PATTERN



Manual Gun Illustration

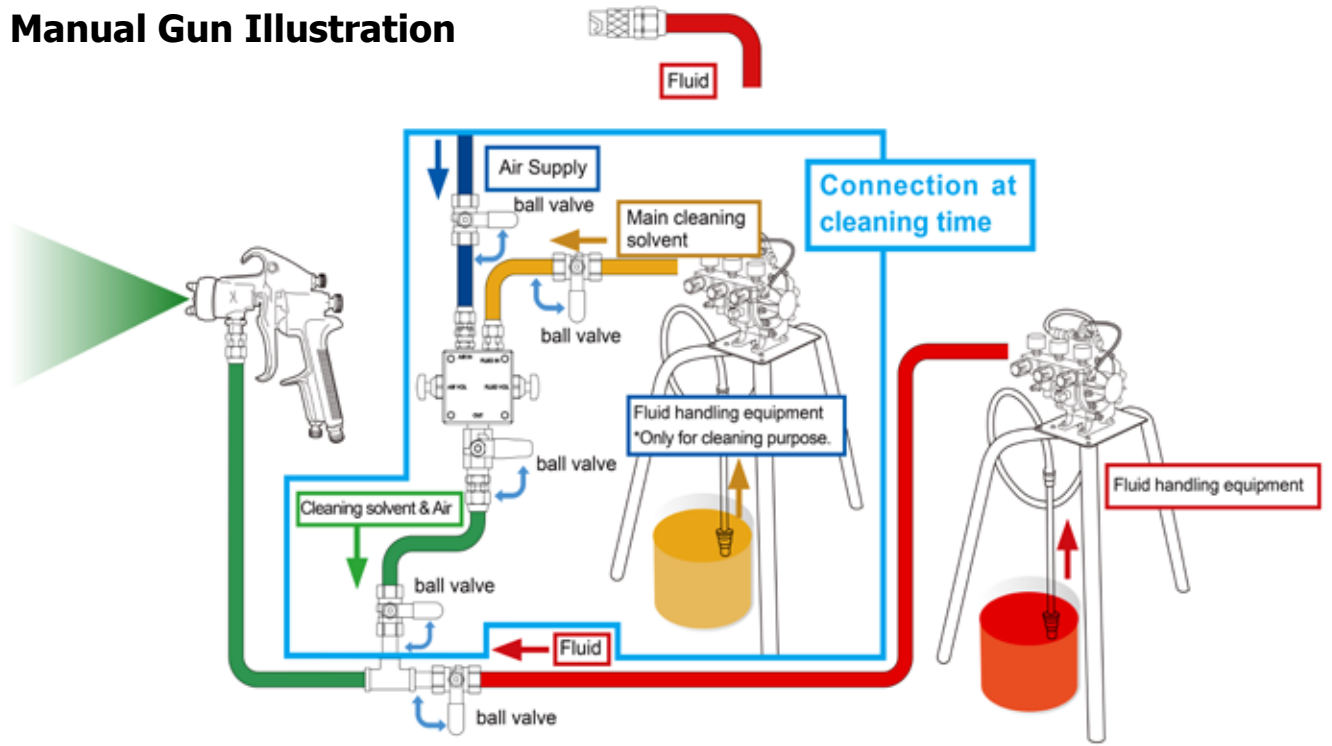

NOTE: All equipment must be grounded to have earth ground.

Automatic Gun Illustration

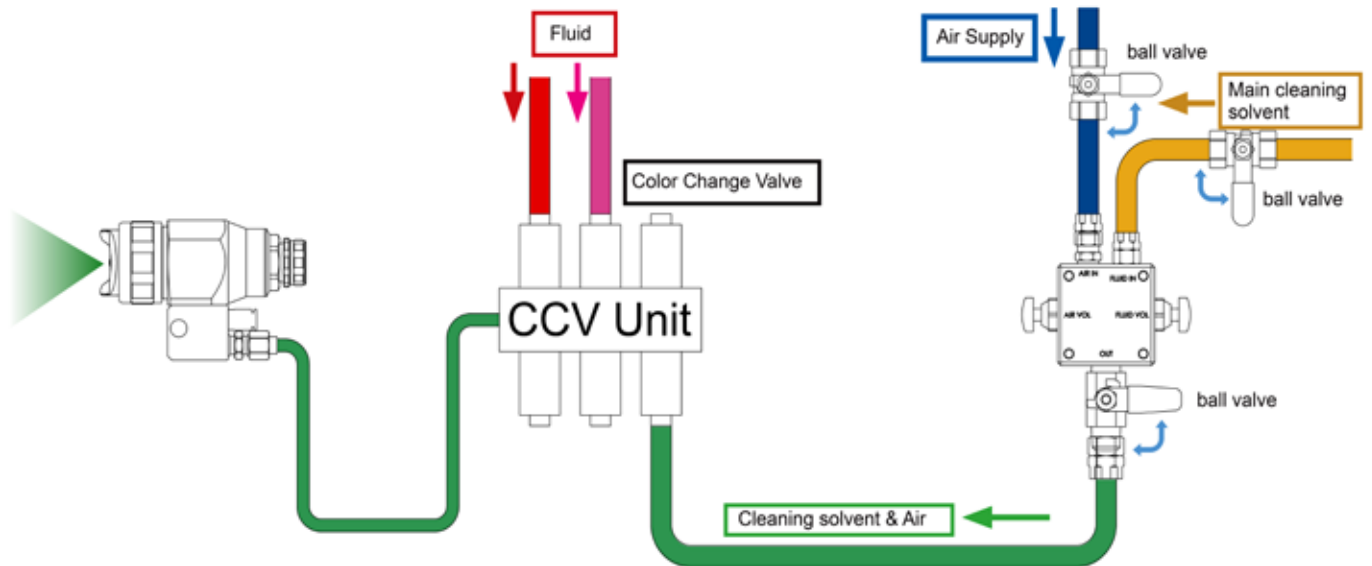

NOTE: All equipment must be grounded to have earth ground.

OPERATION

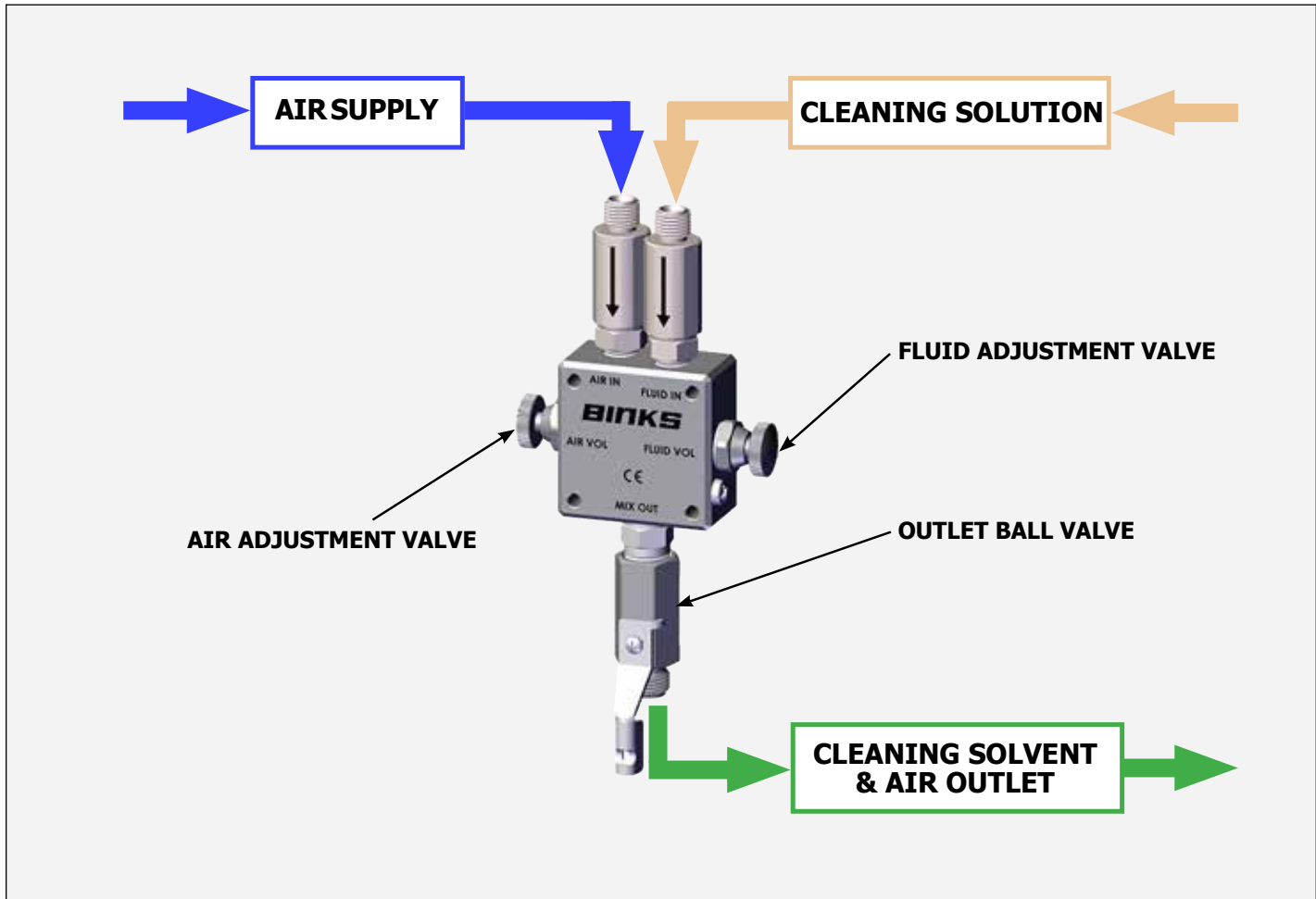

HOW TO USE

1. Do not run dirty paints or dirty cleaning solutions through this device.
2. If the difference of supply pressure between the cleaning solutions and the air is large, mixing will be difficult, so adjust the air supply and cleaning solution supply pressures to the same level in advance.
3. Fully turn the fluid adjustment valve and air adjustment valve knob clockwise for minimum flow. (This does not completely stop flow, and should not be treated as a dedicated on/off valve).

NOTE

- The resistance required to adjust the fluid and air volume knobs is to prevent accidental adjustments and/or changes in adjustment due to vibration.
4. Before opening the outlet valve, make sure that air adjustment valve is opened first and your fluid adjustment valve is opened second. This is another safety precaution to prevent any possible fluid backflow into the air supply

5. How to adjust the cleaning solution flow rate and air flow rate.
 - a. For both knobs, turn clockwise to decrease the flow rate or turn counterclockwise to increase the flow rate.
 - b. Next, turn the air adjustment valve knob to mix the air with the cleaning solutions. (You can also dry the device by turning off cleaning solution supply to let only air flow through the device).
 - c. Next, starting from the full closed position, turn the fluid adjustment valve knob to adjust the flow rate of the cleaning solutions. (Cleaning with nearly only solvent is possible by turning off your air supply or decreasing the air adjustment valve to its minimum flow adjustment).
 - d. Adjust the flow rates of cleaning solutions and the air until the users desired cleaning needs are satisfied.
6. The settings for the fluid adjustment valve and air adjustment valve can be left constant for similar cleaning performance each time the unit is in use.

NOTE

- The unit will need to be readjusted if the fluid/air supply volume or pressure is changed.

MAINTENANCE

CLEANING

1. Perform daily internal cleaning/flushing to ensure the best usability and performance of this device.
2. Never completely immerse in any solvent or cleaning solutions as this can be detrimental to the life of this device. Immersing this device in liquid may deteriorate the seals, resulting in cleaning solution leaks or air leaks.

PARTS IDENTIFICATION

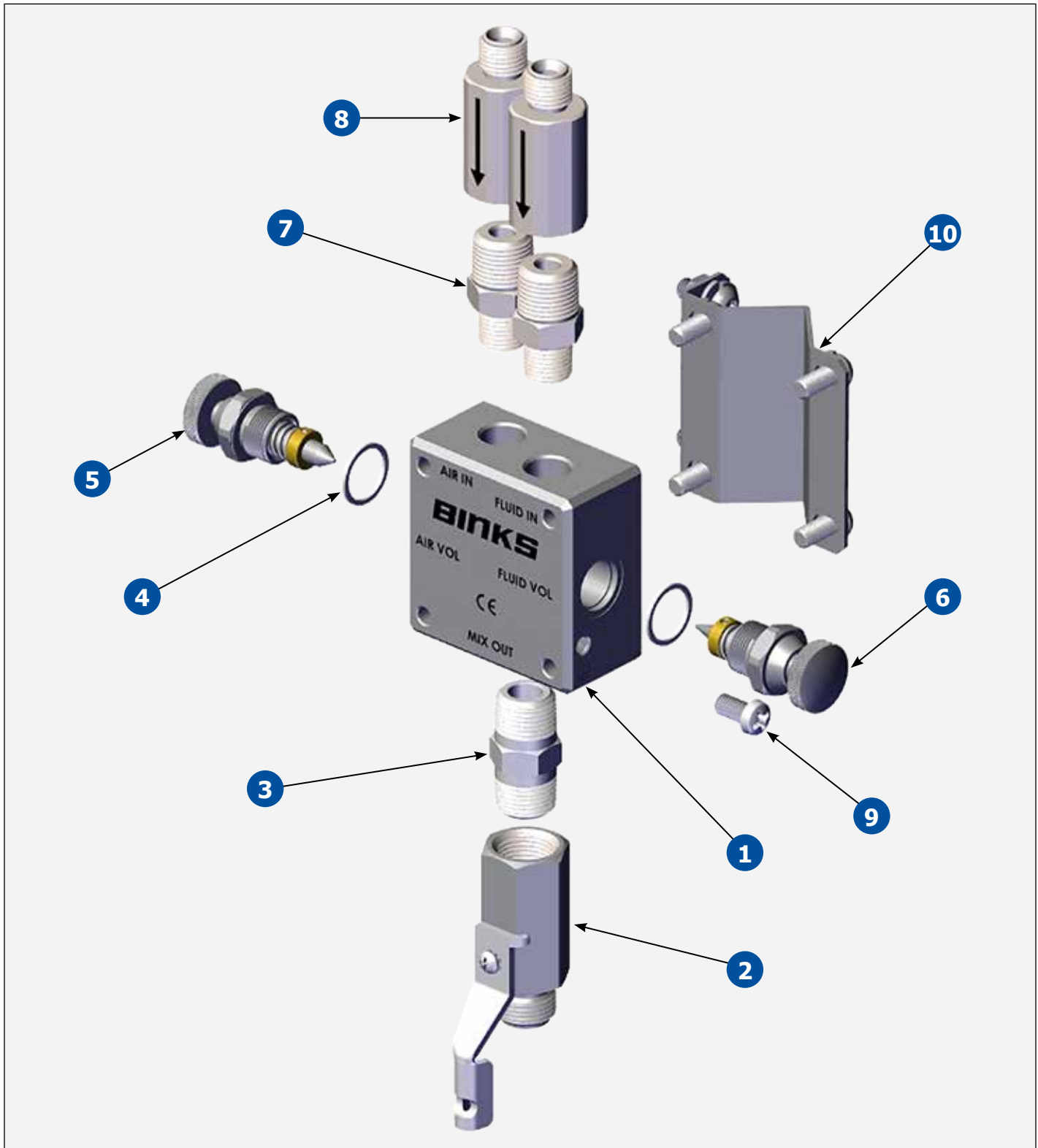
**HD-QCH-500**

HD-QCH-500 - PARTS LIST			
Ref #	Part #	Description	Qty
1	HD-QCH-001	BODY, HD-QCH	1
2	SSBV-6S-316	BALL VALVE, 3/8 NPSM-BSP, 3/8 NPT(F)	1
3	6T-6T	3/8-18 NPT(M) X 3/8 NPT(M) NIPPLE	1
4	HD-QCH-012-K5	SEAL, BUSHING (INCLUDED WITH NEEDLE VALVE ASSEMBLIES) KIT OF 5	1
5	HD-QCH-011	NEEDLE VALVE ASSEMBLY, AIR	1
6	HD-QCH-013	NEEDLE VALVE ASSY, FLUID	1
7	6T-4T	3/8" NPT(M) X 1/4" NPT(M)	2
8	SSCV-4-6T	CHECK VALVE 1/4 NPS(M) X 3/8 NPT(F)	2
9	QSK-006	SCREW M5 X 1.0 - 12MM PHILLIPS, GROUND	1
10	HD-QCH-002	ASSY, MOUNTING BRACKET (INCLUDES ALL FASTNERS)	1
11	QSK-006	ASSY, GROUNDING WIRE	1*

*Recommended for use with device, not shown in diagram, not included, sold separately.

WARRANTY POLICY

This product is covered by Carlisle Fluid Technologies' materials and workmanship limited warranty. The use of any parts or accessories, from a source other than Carlisle Fluid Technologies, will void all warranties. Failure to reasonably follow any maintenance guidance provided, may invalidate any warranty.

For specific warranty information please contact Carlisle Fluid Technologies.

For technical assistance or to locate an authorized distributor, contact one of our international sales and customer support locations.

Region	Industrial / Automotive	Automotive Refinishing
Americas	Tel: 1-800-992-4657 Fax: 1-888-246-5732	Tel: 1-800-445-3988 Fax: 1-800-445-6643
Europe, Africa Middle East, India	Tel: +44 (0)1202 571 111 Fax: +44 (0)1202 573 488	
China	Tel: +8621-3373 0108 Fax: +8621-3373 0308	
Japan	Tel: +81 45 785 6421 Fax: +81 45 785 6517	
Australia	Tel: +61 (0) 2 8525 7555 Fax: +61 (0) 2 8525 7575	

For the latest information about our products, visit www.carlisleleft.com.

Carlisle Fluid Technologies is a global leader in innovative finishing technologies.
Carlisle Fluid Technologies reserves the right to modify equipment specifications without prior notice.

BGK™, Binks®, DeVilbiss®, Hosco®, MS®, and Ransburg®
are registered trademarks of Carlisle Fluid Technologies, LLC.

©2023 Carlisle Fluid Technologies, LLC.
All rights reserved.



16430 North Scottsdale Rd.
Scottsdale, AZ 85254 USA